

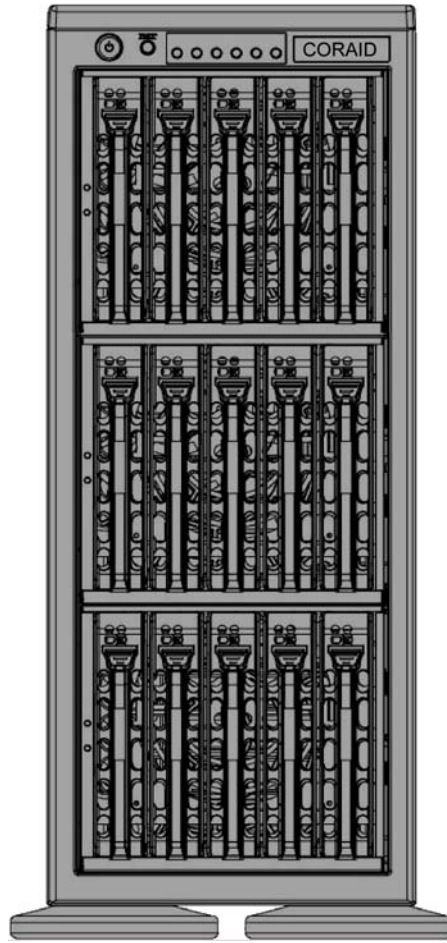

The Linux Storage People



SR1521T (4U Tower - 15Disk)

EtherDrive[®] Storage Installation Guide

Updated 4 February 2007

Thank you for purchasing EtherDrive® Storage. A simple Ethernet connected shared disk storage device accessed using the ATA-over-Ethernet (AoE) protocol.

EtherDrive® Storage consists of a free standing chassis appliance equipped with slots for SATA disks.

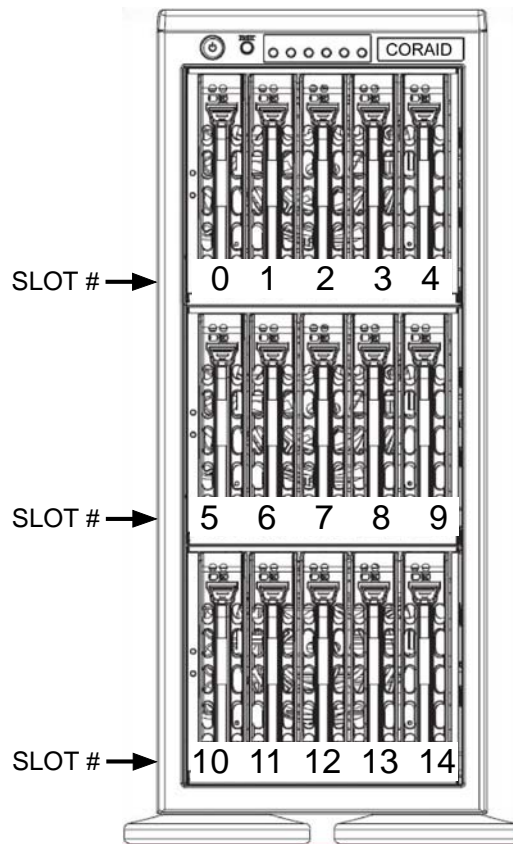

SR1521T – Model # CED4U15ST

Control Panel and Indicator LEDs

The EtherDrive® Storage shelf is equipped with color LED indicators and buttons located on the front panel.

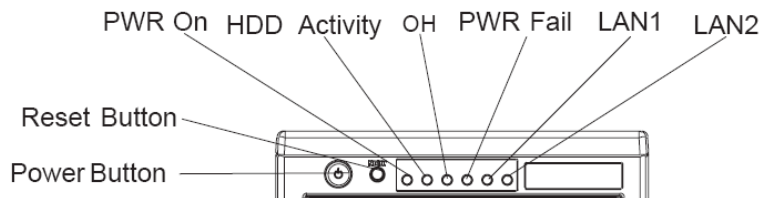

Control Panel

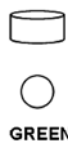

Each disk carrier also has a light pipe indicator to show disk status. Green “Flashing/On” during disk activity.

Package Contents

- One CED4U15ST shelf assembly
- IEC power cord(s)
- Screws to mount SATA disk to disk drive trays

Safety Precautions

- CED4U15ST weighs more than 50 pounds. Use 2 people to lift unit to avoid injury.
- CED4U15ST has hot swap power modules. **Disconnect the power cord from the power supply module before removing the module.**

Quick Installation in 3 easy steps

1. Cabinet Installation and Power Connection

- Locate the shelf in a location with good ventilation and maintain an operating temperature of between 15-25 degrees Celsius. We recommend the sys admin/installer attach a unique shelf number label to the front of the chassis for easy storage unit identification. This shelf number will be used by the sys admin in the first steps of configuration via the storage units console port once physical installation is complete.
- The power supplies in the shelf are auto sensing universal voltage (115/230VAC, 50/60Hz) and they come with IEC connectors. The CED4U15ST shelf is supplied with three power cords for USA power systems. Other user supplied IEC adapter cords may be required to meet power plug needs outside the USA. Coraid highly recommends that the SR1521T be connected to an uninterruptable power source (UPS).

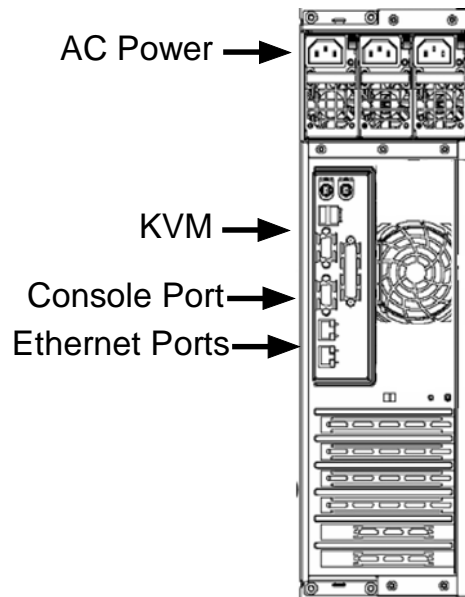

Chassis Rear View

- After connection to an AC power source, press the power switch located on the front panel of the unit and observe that the units fans are operational. The shelf is now ready for disks to be installed.

2. SATA Disk installation

- EtherDrive® Storage is designed to accommodate standard 3.5" SATA disk drives. Press the colored release tab located on the drive tray door to release the drive tray from its locking position and extend the extraction handle to withdraw the drive tray.

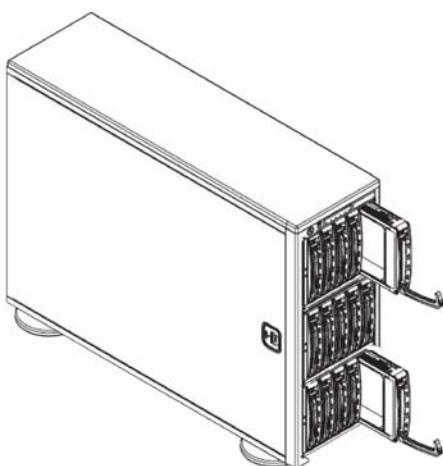

Disk Carrier Eject

- b. (Note: Disk trays are initially supplied with a plastic blank where the disk is installed. This plastic blank also provides an air flow restriction to slots that are not yet inhabited by disks. Do not remove the plastic blank until you are ready to install a disk in its place, to maintain proper air flow within the shelf.) Remove the plastic blank attached to the disk drive tray and install a SATA disk drive in its place using six screws provided.

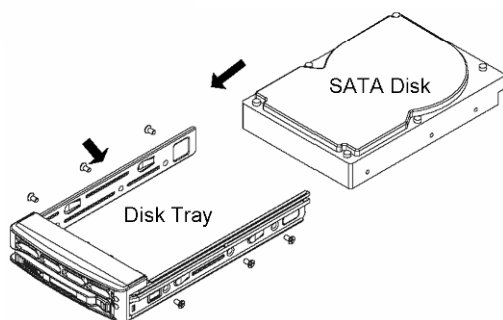

- c. The disk and tray is now ready to be plugged into its slot in the shelf.

3. Shelf Address Configuration & Network Connection

- a. **IMPORTANT NOTE:** Each shelf sharing a common Ethernet network must have a **unique** address to prevent an address conflicting which may disrupt operation of other storage devices on the network
- b. Connect a terminal to the serial com port (Com1 settings are 9600 N 1) or KVM ports on the back of the unit.
- c. Now refer to the software manual for configuration setup.
- d. CED4U15ST EtherDrive® Storage appliances have two Gigabit Ethernet connections on the rear of the shelf. Use **CAT6** Ethernet cable only to connect to a GigE Ethernet switch or directly a Server. Cross over cables are not required. The SR1521T will auto negotiate the connection speed and cable connection polarity.
- e. If using an Ethernet switch please insure it can support 802.3x (flow control) and jumbo Ethernet frames. Most modern Ethernet switches support these standards.
- f. Install the latest AoE software driver on each Server that will be accessing the EtherDrive Storage. This can be downloaded from Coraid's web site at www.coraid.com/support
- g. EtherDrive Storage is now ready and accessible by the network connected Servers, equipped with ATA-over-Ethernet (AoE) drivers. Please consult the Coraid web site www.coraid.com/support for helpful "HOWTO" information.

**CAUTION !! – DO NOT SHIP PRODUCT WITH DISKS INSTALLED.
THIS MAY DAMAGE UNIT AND WILL VOID THE WARRANTY**

Warranty and Return Policy

Coraid Inc. ("Coraid") provides this Limited warranty to the entity that originally purchased the CORAID product.

Limited Warranty: CORAID warrants that the Hardware portion of the CORAID products described below will be free from material defects in workmanship and materials from the date of original purchase of the product, for the period of thirty six (36) months ("Warranty Period")

CORAID's sole obligation shall be to repair or replace the defective Hardware during the Warranty Period at no charge to the original owner or to refund at CORAID's sole discretion. Such repair or replacement will be rendered by CORAID at CORAID's Service Center. The replacement Hardware need not be new or have an identical make, model or part. CORAID may in its sole discretion replace the defective Hardware (or any part thereof) with any reconditioned product that CORAID reasonably determines is substantially equivalent (or superior) in all material respects to the defective Hardware. Repaired or replacement Hardware will be warranted for the remainder of the original Warranty Period from the date of original retail purchase.

Limited Software Warranty: CORAID warrants that the software portion of the product ("Software") will substantially conform to CORAID's then current functional specifications for the Software, from the date of original retail purchase of the Software for a period of thirty six (36) months ("Warranty Period").

Submitting A Claim: The customer shall return the product to the original purchase point based on its return policy. In case the return policy period has expired and the product is within warranty, the customer shall submit a claim to CORAID as outlined below: The customer must submit with the product as part of the claim a written description of the Hardware defect or Software nonconformance in sufficient detail to allow CORAID to confirm the same.

1. The original product owner must obtain a Return Material Authorization ("RMA") number from the CORAID Service Center.
2. After an RMA number is issued, the defective product must be packaged securely in suitable shipping package to ensure that it will not be damaged in transit, and the RMA number must be prominently marked on the outside of the package.
3. The customer is responsible for all in-bound shipping charges to CORAID. No Cash on Delivery ("COD") is allowed. Products sent COD will either be rejected by CORAID or become the property of CORAID. Products shall be fully insured by the customer. CORAID will not be held responsible for any packages that are lost in transit to CORAID.
4. Return Merchandise Ship-To Address is Coraid Inc. 565 Research Dr., Athens, Georgia 30605

What Is Not Covered: This limited warranty provided by CORAID does not cover: Products, if in CORAID's judgment, have been subjected to abuse, accident, alteration, modification, tampering, negligence, misuse, faulty installation, lack of reasonable care, repair or service in any way that is not contemplated in the documentation for the product, or if the model or MAC address has been altered, tampered with, defaced or removed; Initial installation, installation and removal of the product for repair, and shipping costs; Operational adjustments covered in the operating manual for the product, and normal maintenance; Damage that occurs in shipment, due to act of God, failures due to power surge, and cosmetic damage; Any hardware, software, firmware or other products or services provided by anyone other than CORAID; Repair by anyone other than CORAID or an Authorized CORAID Service Center will void this Warranty.

Disclaimer of Other Warranties: EXCEPT FOR THE LIMITED WARRANTY SPECIFIED HEREIN, THE PRODUCT IS PROVIDED "AS-IS" WITHOUT ANY WARRANTY OF ANY KIND WHATSOEVER INCLUDING, WITHOUT LIMITATION, ANY WARRANTY OF MERCHANTABILITY, FITNESS FOR A PARTICULAR PURPOSE AND NON-INFRINGEMENT. IF ANY IMPLIED WARRANTY CANNOT BE DISCLAIMED IN ANY TERRITORY WHERE A PRODUCT IS SOLD, THE DURATION OF SUCH IMPLIED WARRANTY SHALL BE LIMITED TO NINETY (90) DAYS. EXCEPT AS EXPRESSLY COVERED UNDER THE LIMITED WARRANTY PROVIDED HEREIN, THE ENTIRE RISK AS TO THE QUALITY, SELECTION AND PERFORMANCE OF THE PRODUCT IS WITH THE PURCHASER OF THE PRODUCT.

Limitation of Liability: TO THE MAXIMUM EXTENT PERMITTED BY LAW, CORAID IS NOT LIABLE UNDER ANY CONTRACT, NEGLIGENCE, STRICT LIABILITY OR OTHER LEGAL OR EQUITABLE THEORY FOR ANY LOSS OF USE OF THE PRODUCT, INCONVENIENCE OR DAMAGES OF ANY CHARACTER, WHETHER DIRECT, SPECIAL, INCIDENTAL OR CONSEQUENTIAL (INCLUDING, BUT NOT LIMITED TO, DAMAGES FOR LOSS OF GOODWILL, LOSS OF REVENUE OR PROFIT, WORK STOPPAGE, COMPUTER FAILURE OR MALFUNCTION, FAILURE OF OTHER EQUIPMENT OR COMPUTER PROGRAMS TO WHICH CORAID'S PRODUCT IS CONNECTED WITH, LOSS OF INFORMATION OR DATA CONTAINED IN, STORED ON, OR INTEGRATED WITH ANY PRODUCT RETURNED TO CORAID FOR WARRANTY SERVICE) RESULTING FROM THE USE OF THE PRODUCT, RELATING TO WARRANTY SERVICE, OR ARISING OUT OF ANY BREACH OF THIS LIMITED WARRANTY, EVEN IF CORAID HAS BEEN ADVISED OF THE POSSIBILITY OF SUCH DAMAGES. THE SOLE REMEDY FOR A BREACH OF THE FOREGOING LIMITED WARRANTY IS REPAIR, REPLACEMENT OR REFUND OF THE DEFECTIVE OR NON-CONFORMING PRODUCT. THE MAXIMUM LIABILITY OF CORAID UNDER THIS WARRANTY IS LIMITED TO THE PURCHASE PRICE OF THE PRODUCT COVERED BY THE WARRANTY. THE FOREGOING EXPRESS WRITTEN WARRANTIES AND REMEDIES ARE EXCLUSIVE AND ARE IN LIEU OF ANY OTHER WARRANTIES OR REMEDIES, EXPRESS, IMPLIED OR STATUTORY

Governing Law: This Limited Warranty shall be governed by the laws of the State of Georgia. Some states do not allow exclusion or limitation of incidental or consequential damages, or limitations on how long an implied warranty lasts, so the foregoing limitations and exclusions may not apply. This limited warranty provides specific legal rights and the product owner may also have other rights which vary from state to state.

Copyright Statement: No part of this documentation accompanying this Product may be reproduced in any form or by any means without permission from CORAID as stipulated by the United States Copyright. Copyright © 2003 by CORAID Inc. All rights reserved. **Trademarks:** EtherDrive is a registered trademark of CORAID Inc.

FCC: This equipment has been tested and found to comply with the limits for a Class A digital device, pursuant to part 15 of the FCC Rules.